

LES REACTIFS

COMBUSTIBLE :
Carbone, HC

Activation :
étincelle, flamme

COMBURANT :
Dioxygène O2

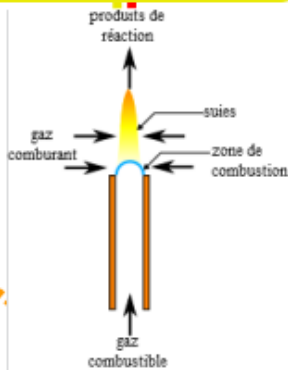

La COMBUSTION



Les PRODUITS

COMPLETE
Exces de Comburant

CO2 , H2O

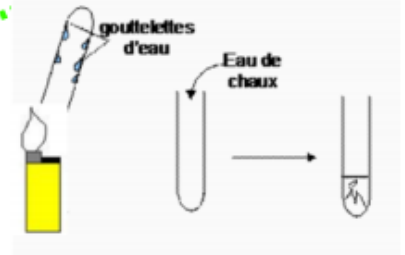

INCOMPLETE
Défaut de Comburant

C; CO2,CO, H2O



Les TRANSFORMATIONS Chimiques

Des REACTIFS sont CONSOMMES → de NOUVEAUX PRODUITS sont FORMES

La MASSE se conserve
La MASSE des REACTIFS = La MASSE des PRODUITS

Les ATOMES se conservent
en NATURE et en NOMBRE

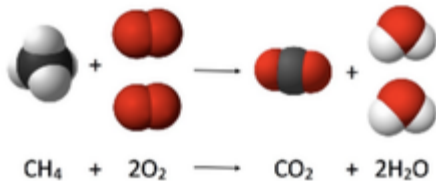
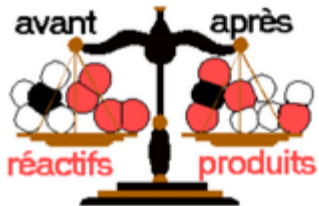

LA MATIERE et ses constituants

partie composant toute la matière inerte et vivante













ATOMES

SYMBOLE et Modélisation

regroupement d'atomes

MOLECULES

FORMULE et Modélisation

CARBONE C 	HYDROGENE H 	 N2 DIAZOTE	 H2O EAU
OXYGENE O 	CHLORE Cl 	 O2 DIOXYGENE	 CO2 DIOXYDE DE CARBONE
AZOTE N 	SOUFRE S 	 CO MONOXYDE DE CARBONE	 CH4 METHANE

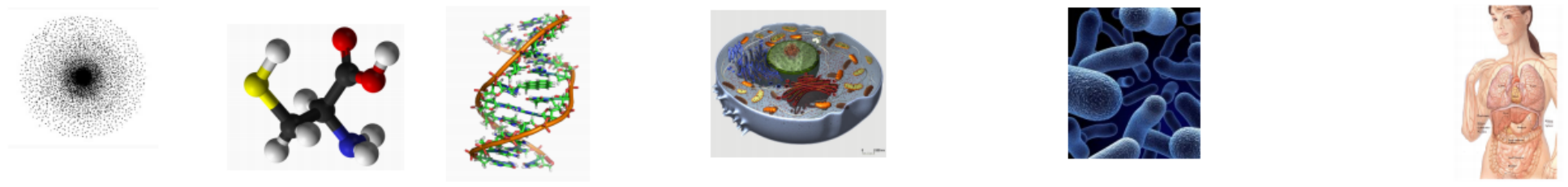
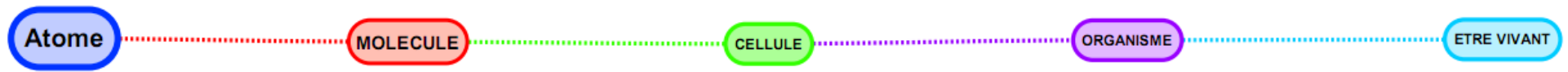

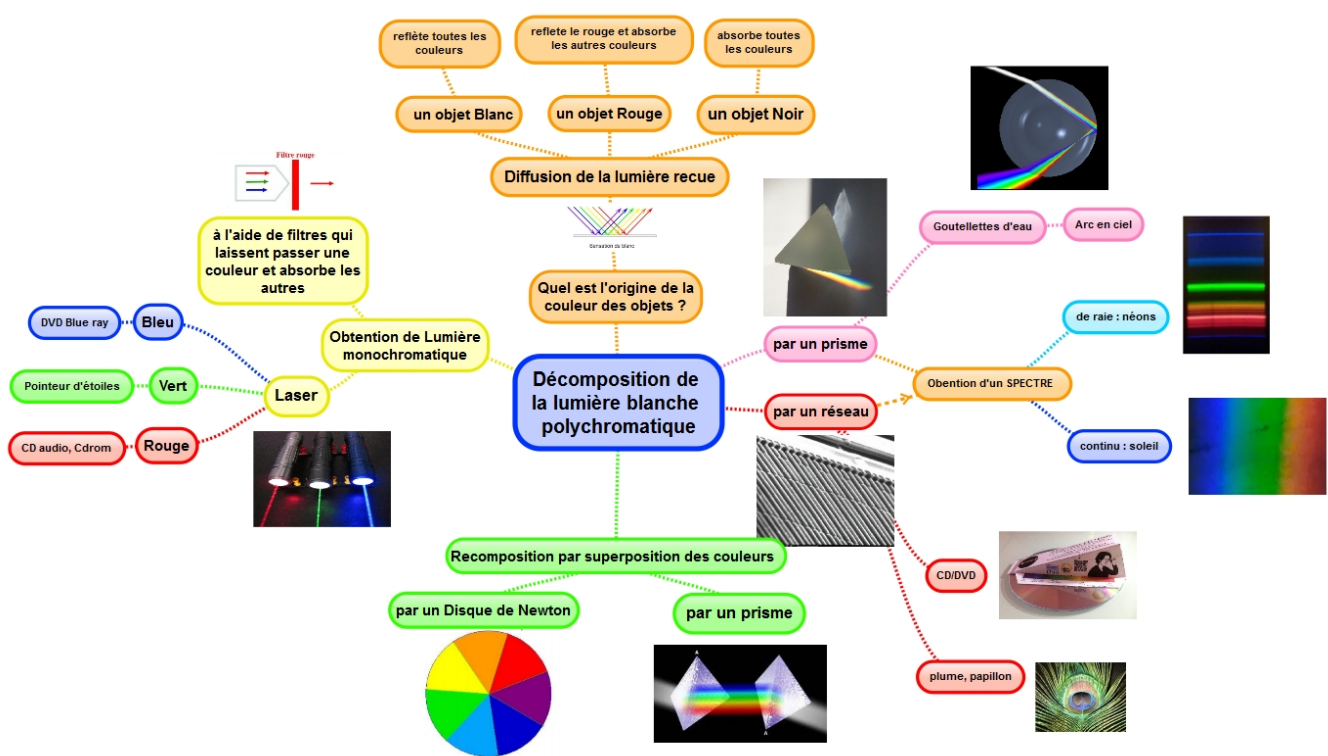

Loupes, Lunettes de vue,
Lunettes astronomiques,
Vidéo-projecteur, APN, portables,....

Où les trouve-t-on ?

Elles sont constituées de matériaux transparents dans
les faces ne sont pas parallèles

Les LENTILLES

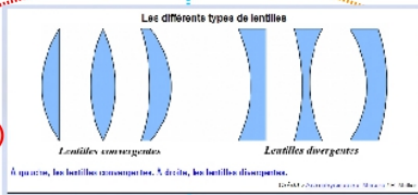

Les convergentes

elles grossissent

Les images peuvent être inversées

Leurs bords sont minces

Les divergentes

Elles réduisent

Les images sont droites

Leurs bords sont épais

Qu'est-ce qui les caractérisent ?

Leur Foyer, F

Point de convergence
des rayons lumineux

Leur focale, f

Distance entre la lentille
et le Foyer

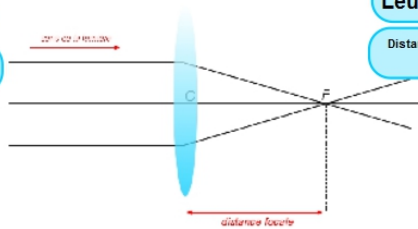

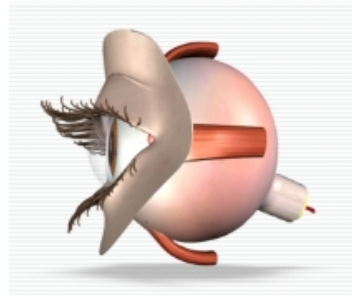

Vue 3D de l'oeil

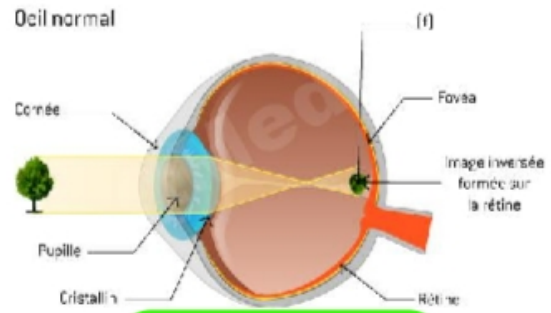

Comment les images se forment-elles ?

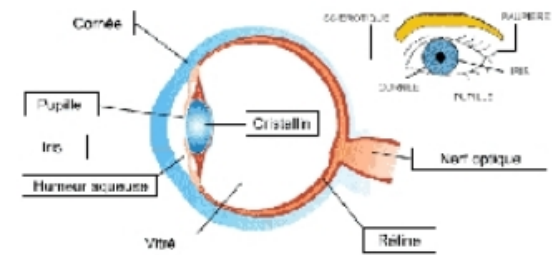

Comment schématiser l'oeil ?

L'oeil

Ses défauts

Qu'est-ce que la Myopie ?

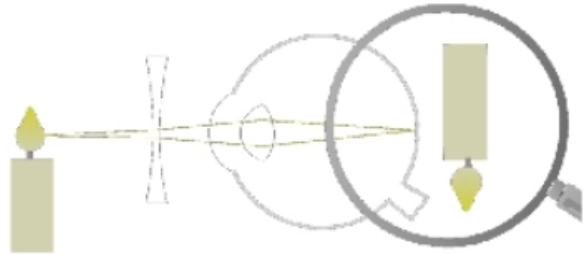

Quelle correction apporter ?
Lunette avec verre CONVERGENT

Qu'est ce que l'Hypermétropie ?

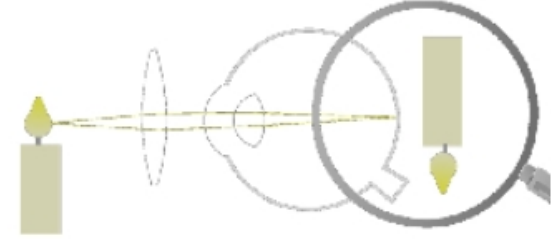

Quelle correction apporter ?
Lunette avec Verre DIVERGENT



se mesure à l'aide d'un AMPEREMETRE



SYMBOLE

Unité : A, mA,

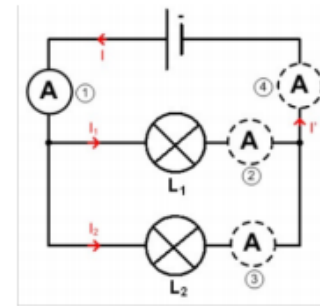

l'Ampere metre se branche en SERIE

ne dépend pas de l'ORDRE des dipôles

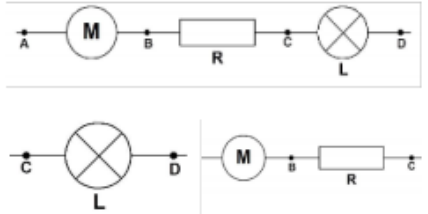

dépend du NOMBRE de dipôles

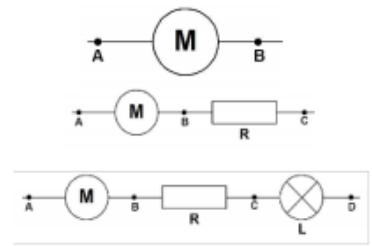

l'INTENSITE électrique : Débit d'électrons

Se DIVISE selon les DERIVATIONS ou BRANCHES

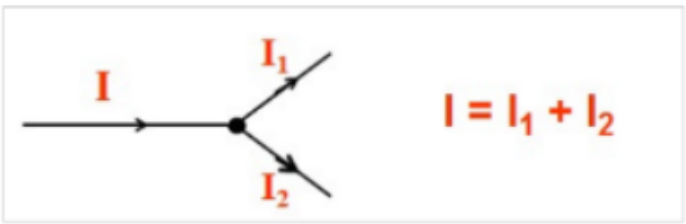
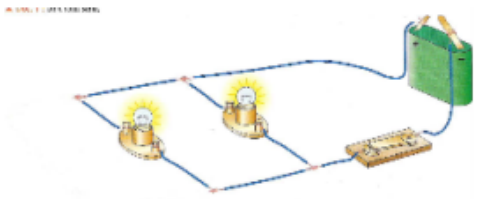

est IDENTIQUE dans un circuit SERIE

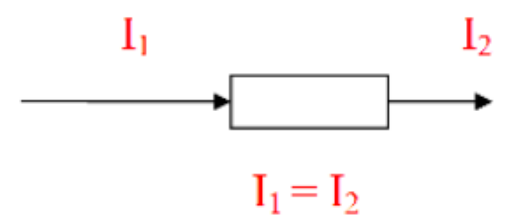

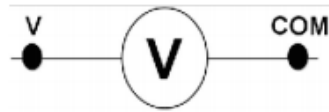

SYMBOLE

Unité : V, mV,

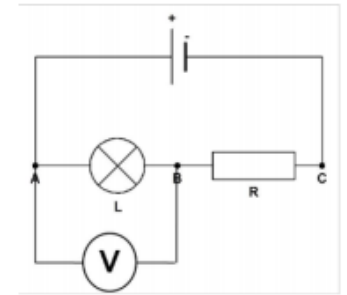
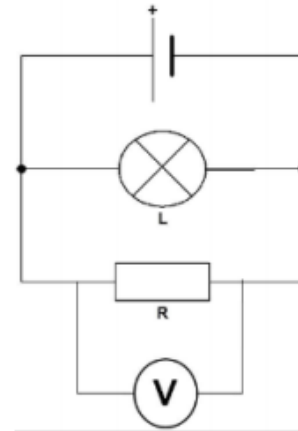

se mesure à l'aide d'un VOLTMETRE

le VOLTMETRE se branche en DERIVATION

La TENSION électrique

est la SOMME des tensions de chaque dipole montés en SERIE

est IDENTIQUE aux bornes des dipoles branchés en DERIVATIONS



$$U_g = U_{L1} + U_{L2}$$



$$U_g = U_{L1} = U_{L2}$$

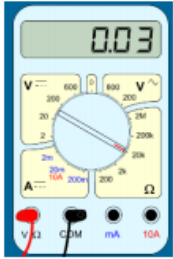

se mesure à l'aide d'un OHMMETRE



SYMBOLE de l'appareil

Unité : O , k O

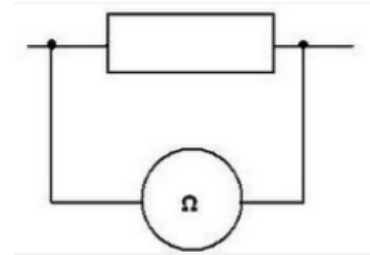

L'OHMMETRE se branche en DERIVATION

d'un circuit SERIE est égale à la SOMME des résistances des dipôles montés en série

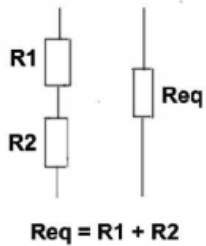

La RESISTANCE, R électrique

traduit sa capacité à RESISTER au passage du courant

Sa VALEUR R peut être déterminée



à l'aide de sa CARACTERISTIQUE $U = f(I)$

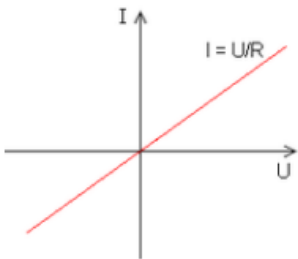

à l'aide d'un OHMMETRE

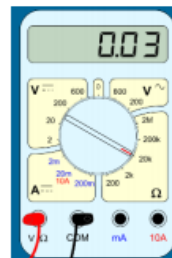

à l'aide du CODE DES COULEURS

